

4

3

2

1

REVISIONS - BALLOONS DENOTE CHANGES			
REV.	DESCRIPTION	DATE	APPROVED
A		6/2/2020	ZAG

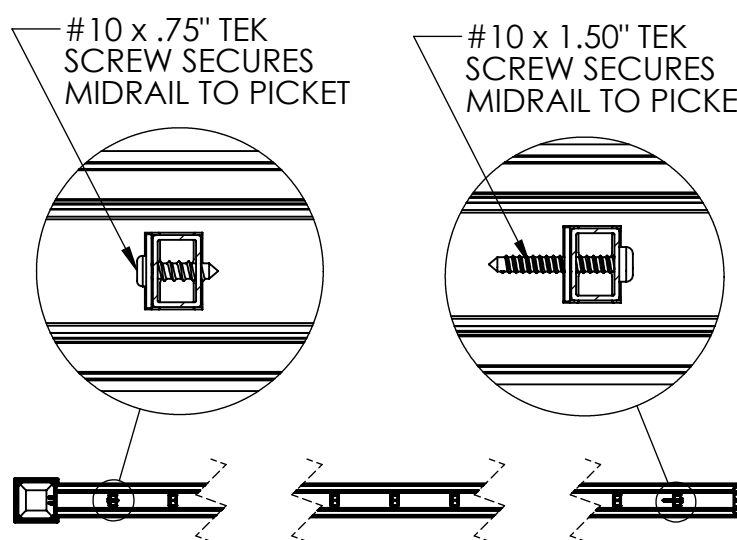
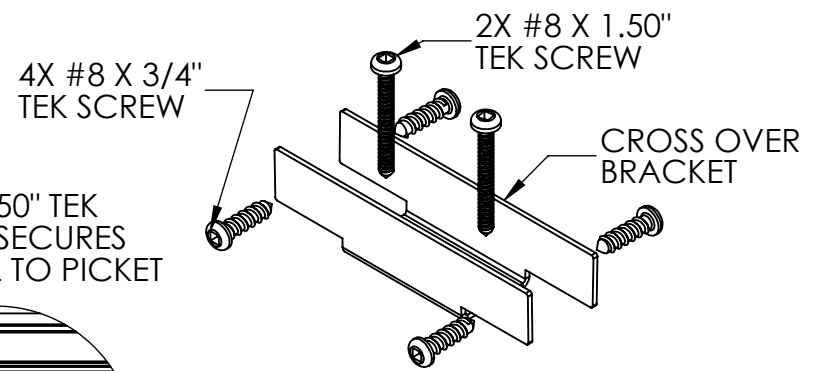
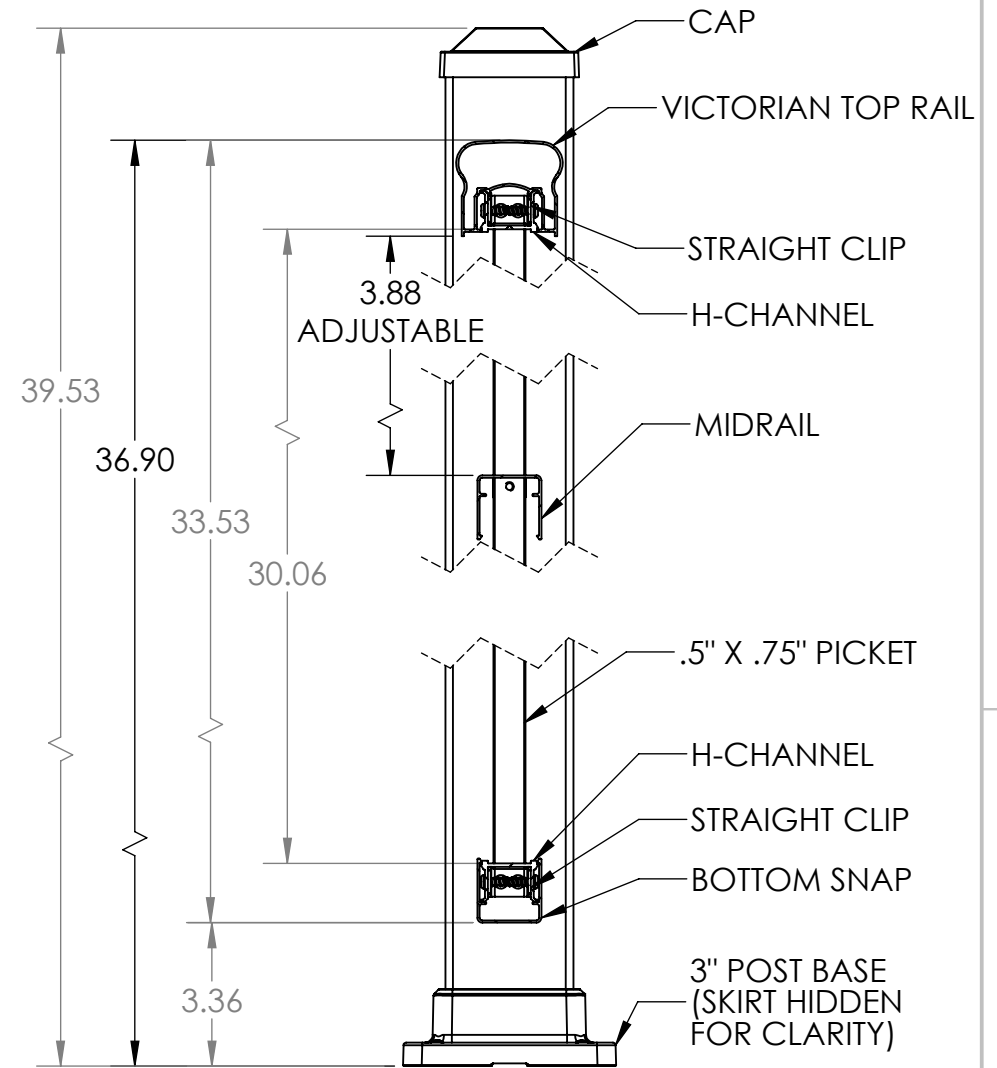
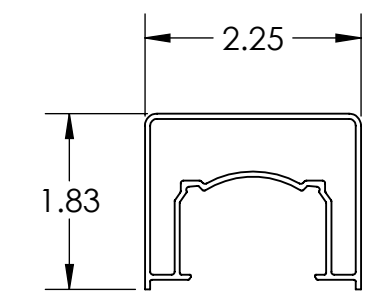
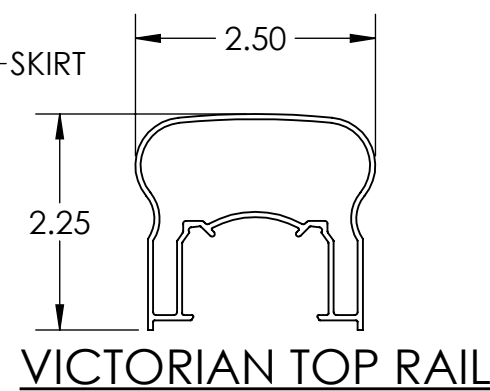
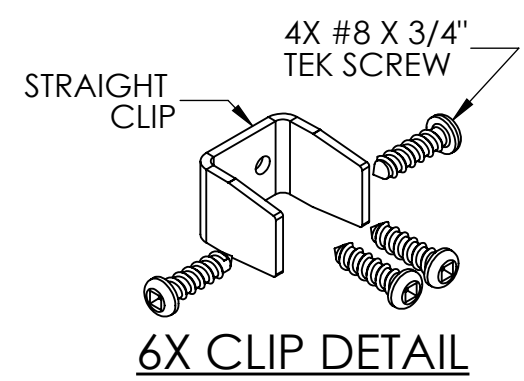
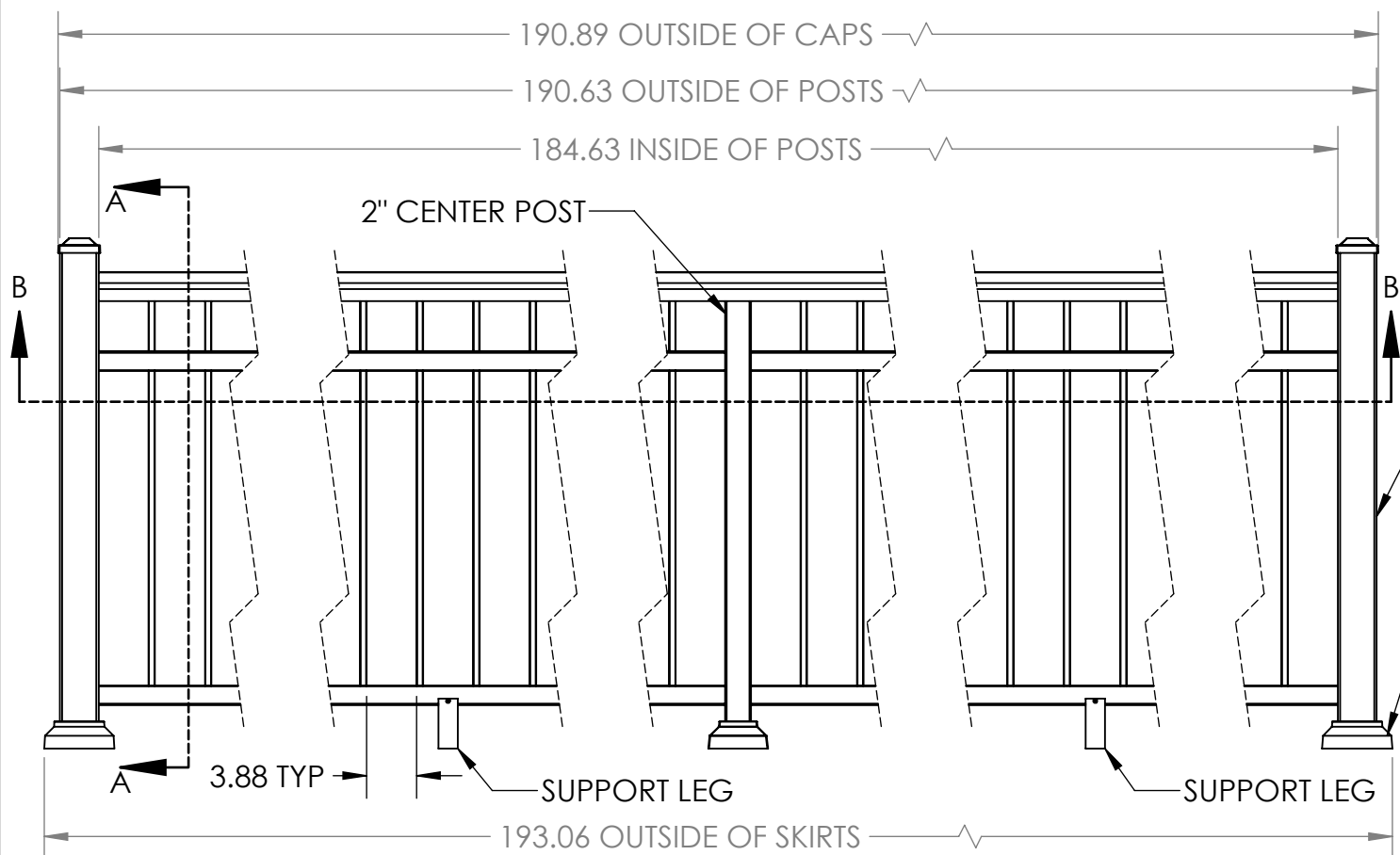

NOTES:
 1. ALL RAIL MUST BE ASSEMBLED AND FASTENED IN ACCORDANCE WITH ULTRALOX'S INSTALLATION INSTRUCTIONS.
 2. AVAILABLE COLORS ARE BLACK - WHITE - BRONZE.

UNLESS OTHERWISE SPECIFIED:		NAME	DATE
DIMENSIONS ARE IN INCHES		DRAWN	DRC 6/2/20
TOLERANCES:		CHECKED	
SURFACE FINISH: 125 RMS		ENG APPR.	
ANGULAR: ±.5 DEG		MFG APPR.	
LINEAR: .X ±.02		INTERPRET GEOMETRIC TOLERANCING PER: ASME Y14.5-2009	
.XX ±.010		MATERIAL	
.XXX ±.005		FINISH	
THIRD ANGLE PROJECTION:		DO NOT SCALE DRAWING	

		TITLE:	
		COMBINATION 36" TOP RAIL PICKET WITH MID RAIL - 3" END POSTS 2" MIDDLE POSTS - BASE MOUNT 8' SECTIONS	
SIZE	DWG. NO.	REV	
B		A	
WEIGHT:		SHEET 1 OF 1	

4

3

2

1